



Prisma 120 und 180 (schmal)

ohne oder mit Armlehne

Recycelte Govaplast Bretter
kombiniert mit 3D-gedruckten Füßen
und Lehnen



Abmessungen

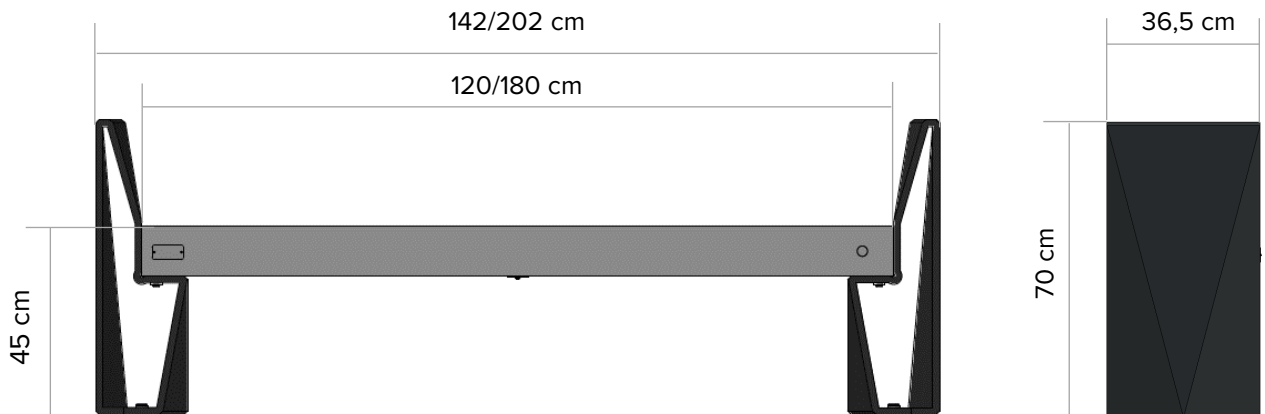
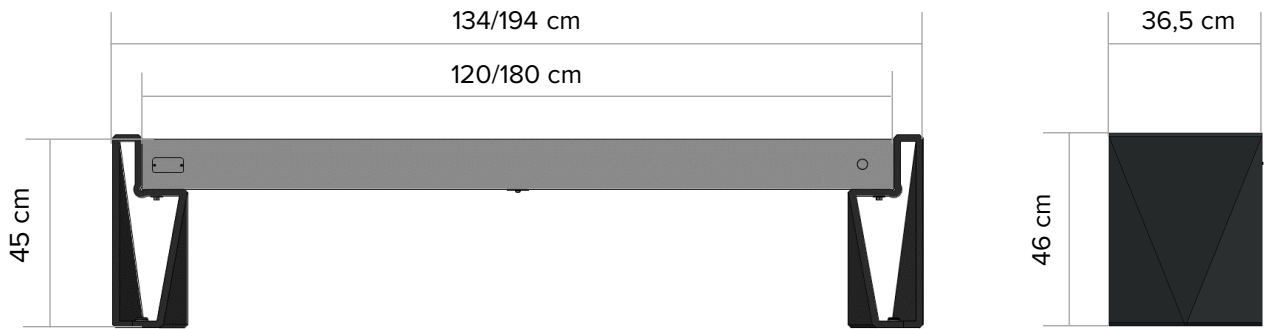

Version 120: 57 kg
Version 120 mit Armlehne: 63 kg
Version 180: 75 kg
Version 180 mit Armlehne : 82 kg

Farben

Bretter

 Mineral Grey

 Sand Beige

FüÙe

 Black

Verstärkung

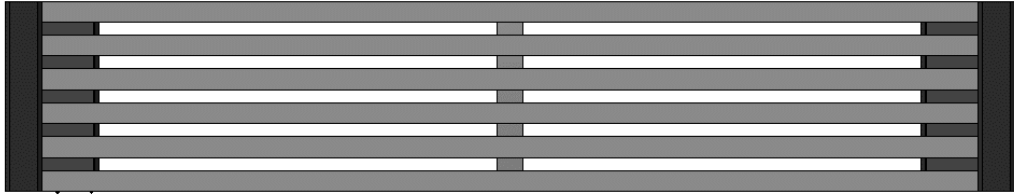

Metallband unter den 6 Brettern verschraubt

Verankerung verpflichtet

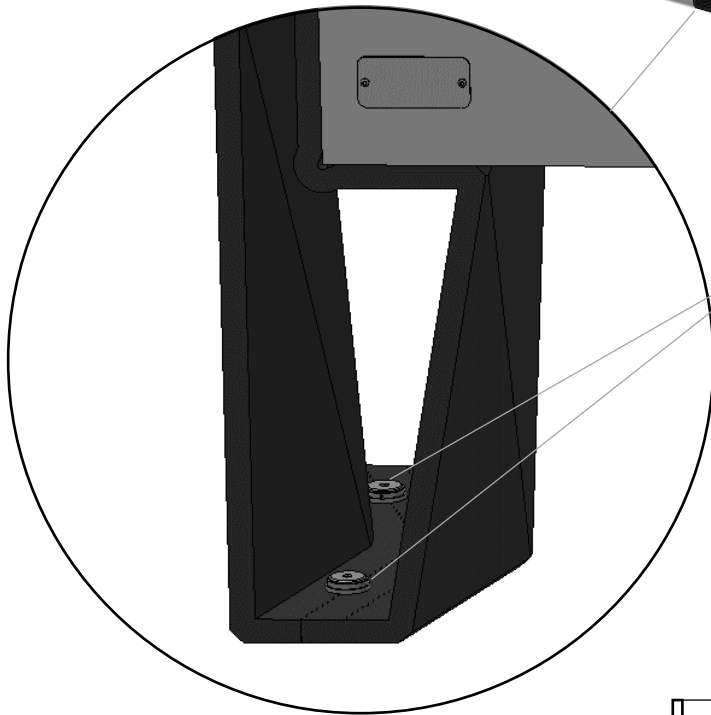
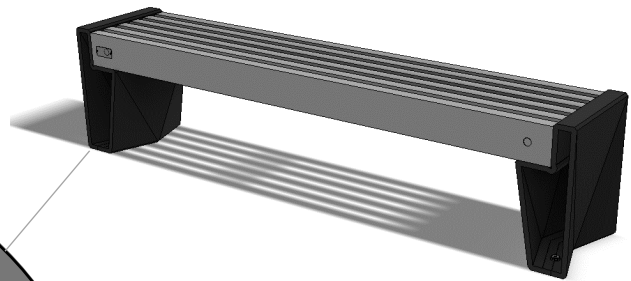

2 für jeden FuB

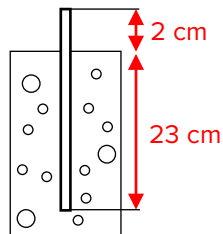
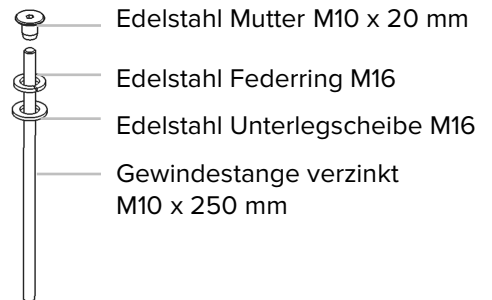

Befestigen Sie die Gewindestange in einem für die Situation geeigneten Beton.



Prisma 120 of 180 (breit)

ohne oder mit Armlehne

Recycelte Govaplast Bretter
kombiniert mit 3D-gedruckten Füßen
und Lehnen



Abmessungen

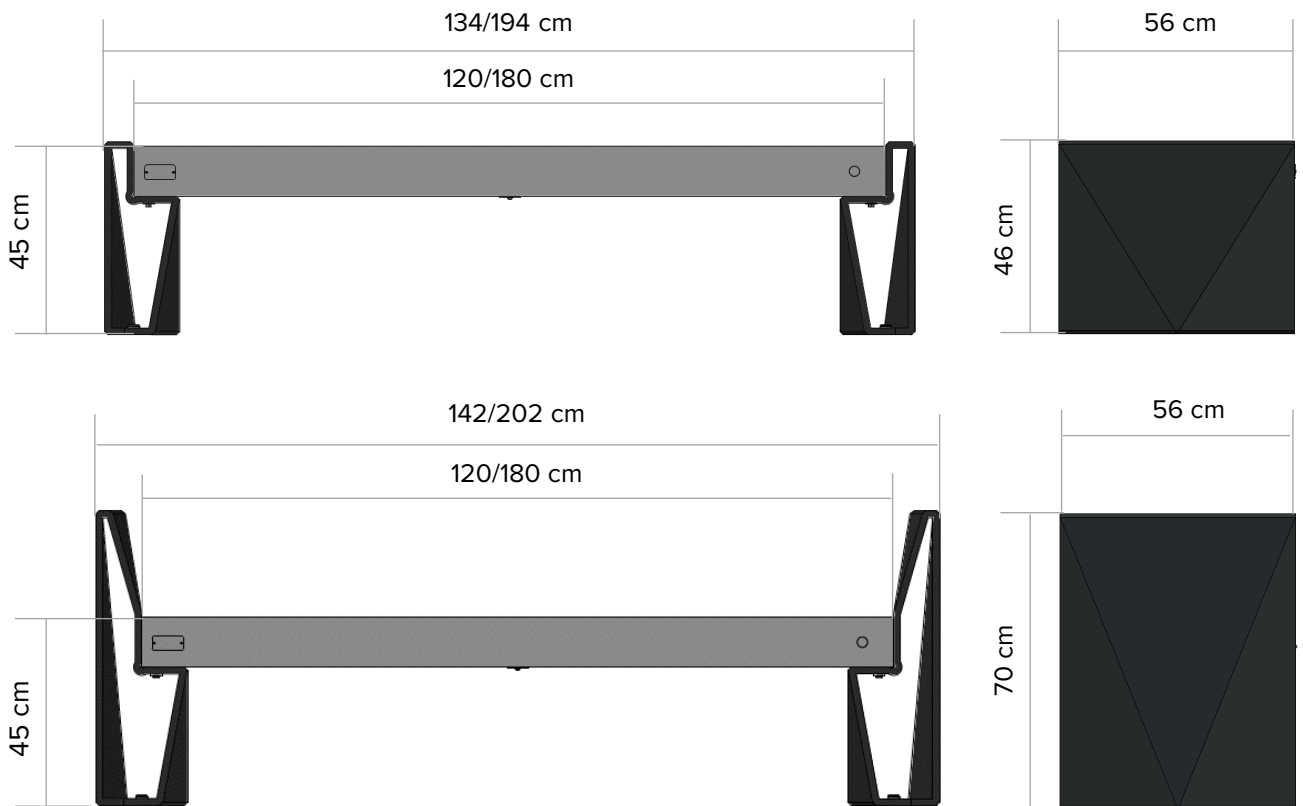

Optionale Rückenlehne
Anzahl und Position frei wählbar

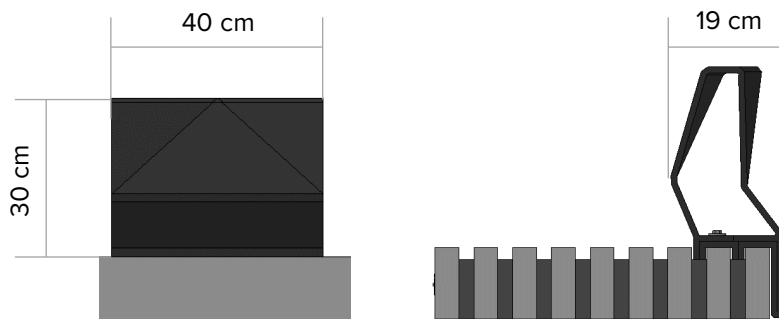

Version 120: 85,5 kg
Version 120 mit Armlehne: 95 kg
Version 180: 114 kg
Version 180 mit Armlehne: 124 kg
eine Rückenlehne: 7 kg

Farben

Bretter

 Mineral Grey

 Sand Beige

FüBe

 Black

Verstärkung

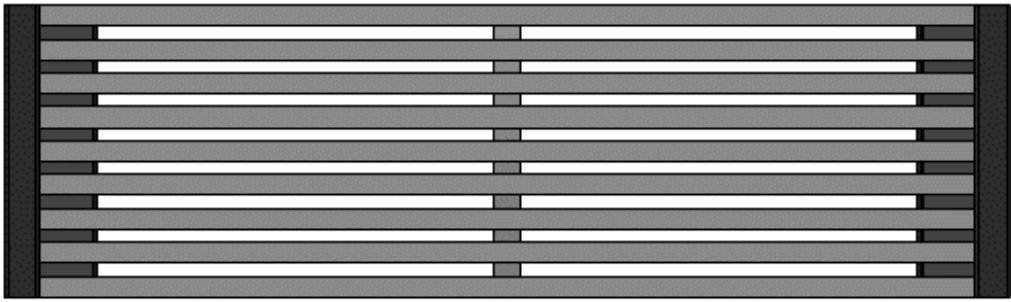

Metallband unter den 9 Brettern verschraubt

Verankerung verpflichtet

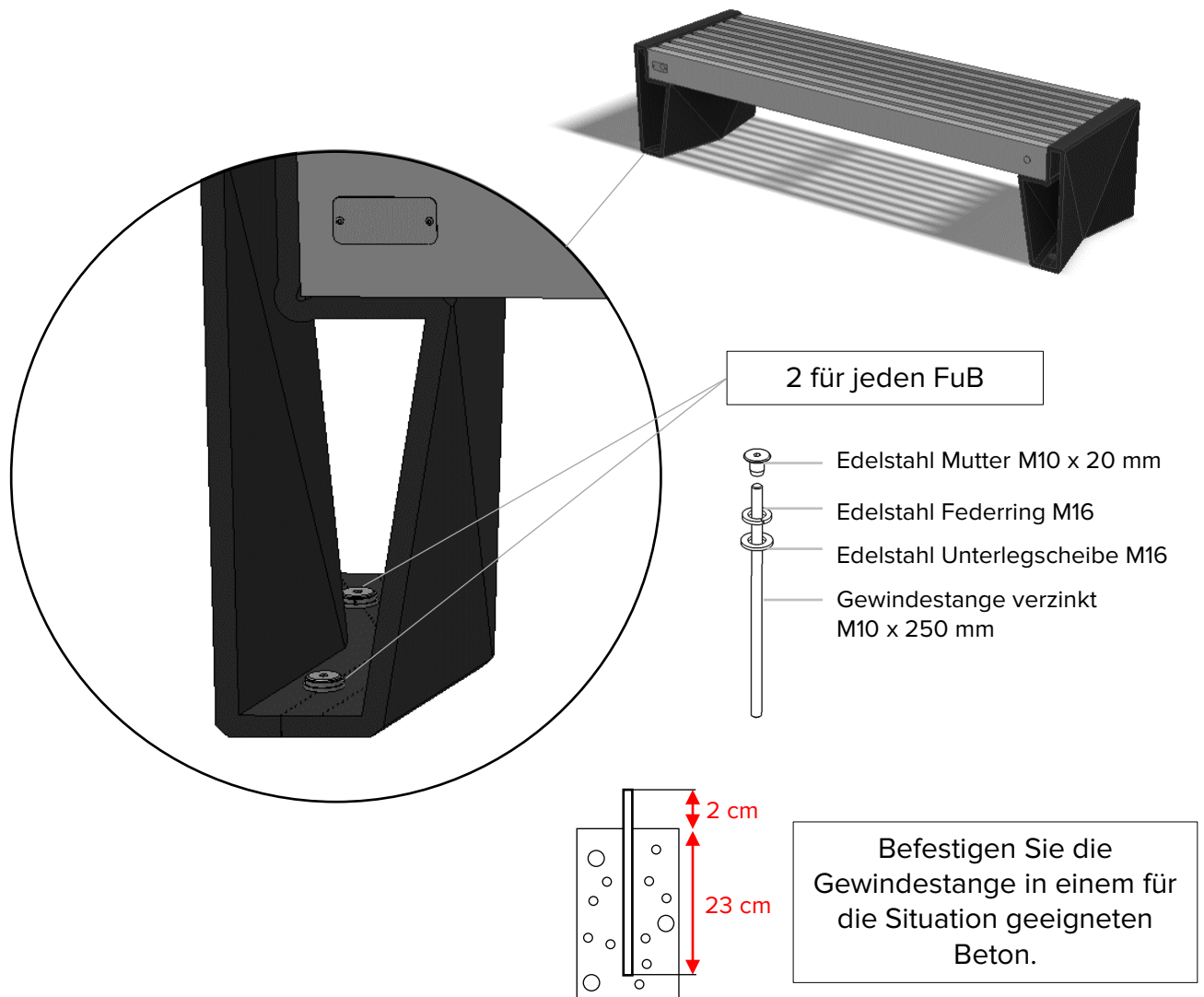



Prisma 360 (schmal)

ohne oder mit Armlehne

Recycelte Govaplast Bretter
kombiniert mit 3D-gedruckten Füßen
und Lehnen



Abmessungen

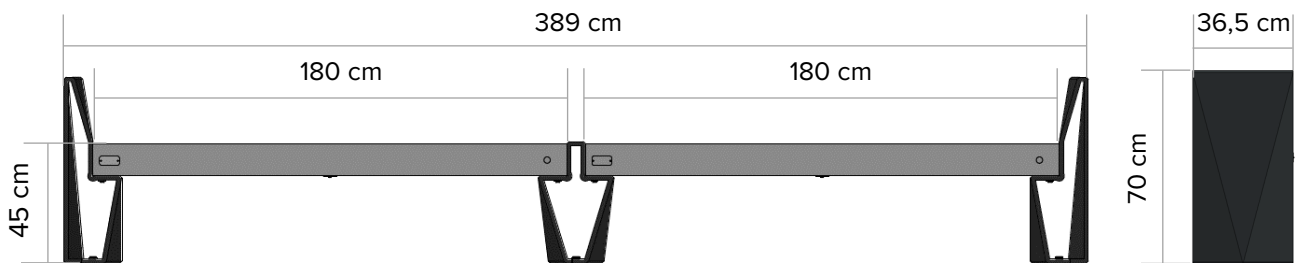
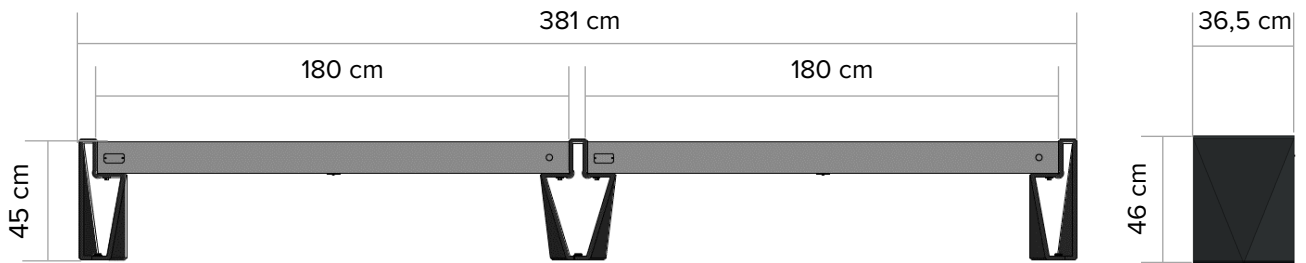

Version 360: 145 kg
Version 360 mit Armlehne: 152 kg

Farben

Bretter

 Mineral Grey

 Sand Beige

FüBe

 Black

Verstärkung

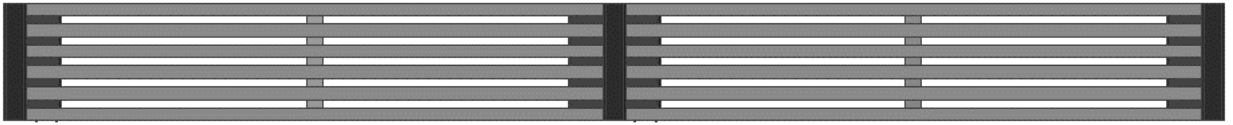

Metallband unter den 6 Brettern verschraubt

Verankerung verpflichtet

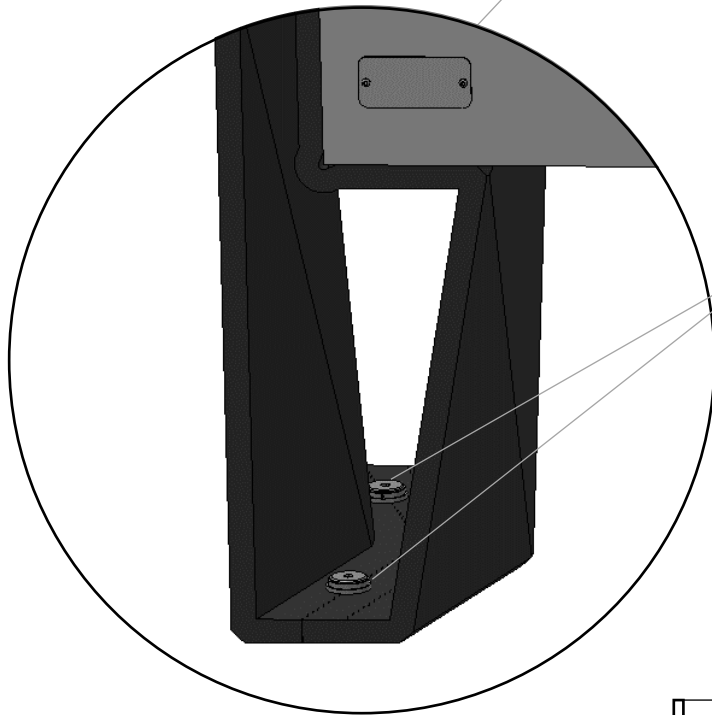
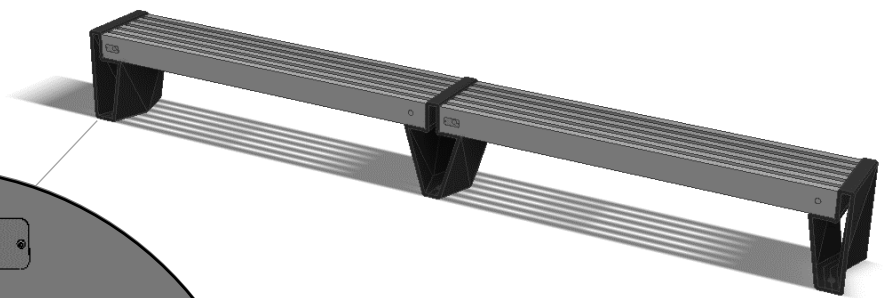

2 für jeden Fuß

- Edelstahl Mutter M10 x 20 mm
- Edelstahl Federring M16
- Edelstahl Unterlegscheibe M16
- Gewindestange verzinkt M10 x 250 mm

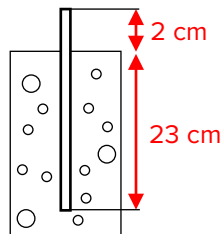

Befestigen Sie die Gewindestange in einem für die Situation geeigneten Beton.

GOVA[®] street
PLAST



Prisma 360 (breit)

ohne oder mit Armlehne

Recycelte Govaplast Bretter
kombiniert mit 3D-gedruckten Füßen
und Lehnen



Abmessungen

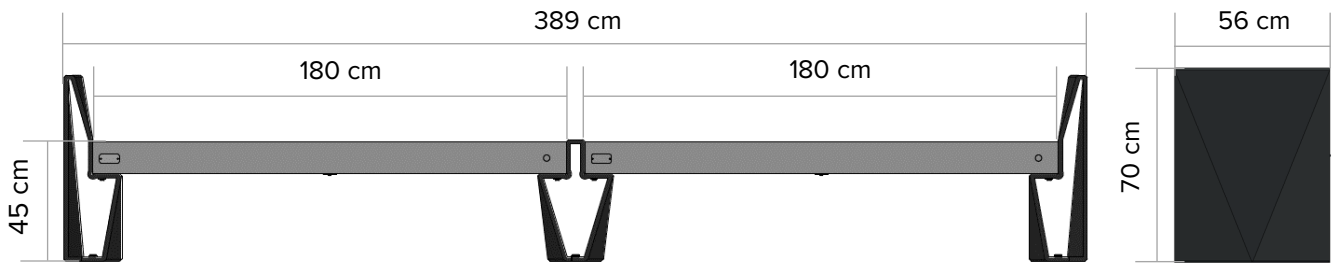
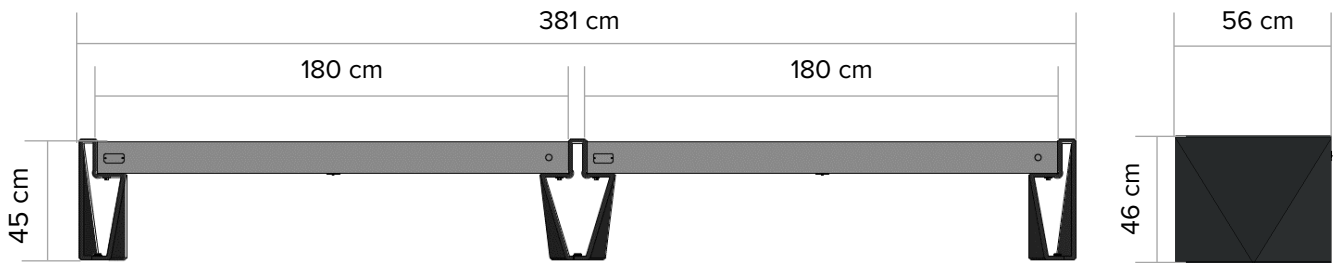

Optionale Rückenlehne
Anzahl und Position frei wählbar

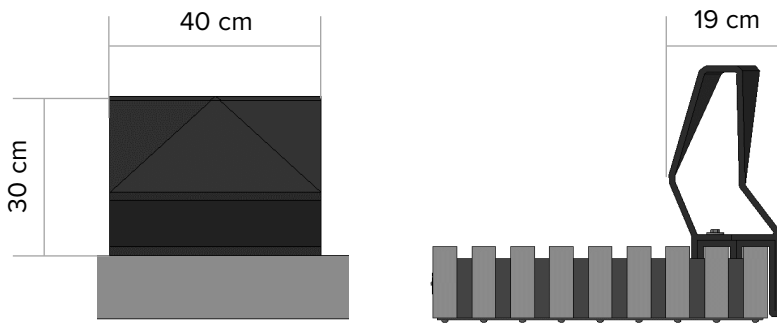

Version 360: 218,5 kg
Version 360 mit Armlehne: 228 kg
Eine Rückenlehne: 7 kg

Farben

Bretter

 Mineral Grey

 Sand Beige

FüBe

 Black

Verstärkung

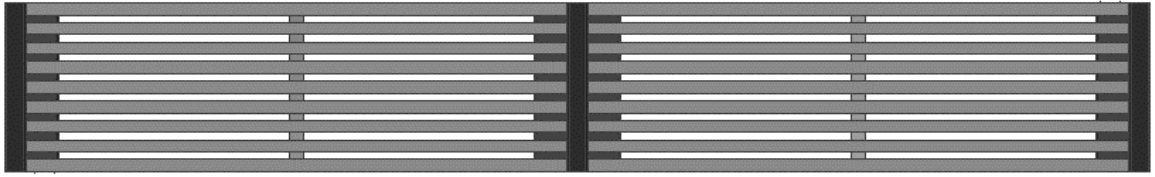

Metallband unter den 9 Brettern verschraubt

Verankerung verpflichtet

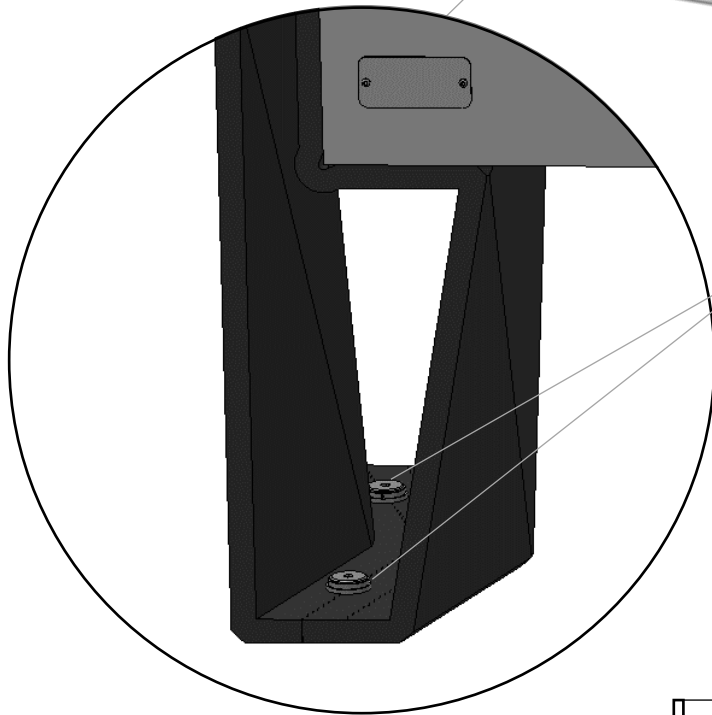
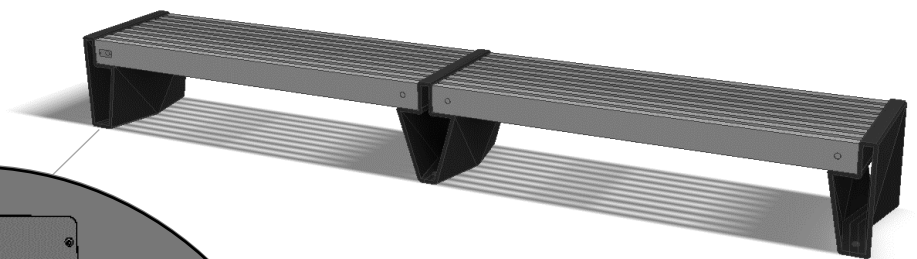

2 für jeden Fuß

- Edelstahl Mutter M10 x 20 mm
- Edelstahl Federring M16
- Edelstahl Unterlegscheibe M16
- Gewindestange verzinkt M10 x 250 mm

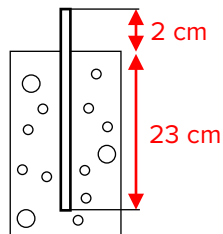

Befestigen Sie die Gewindestange in einem für die Situation geeigneten Beton.