



Prisma 120 et 180 (étroit)

avec ou sans dossier

Govoplast planches recyclées
en combinaison avec des
pieds imprimés en 3D



dimensions

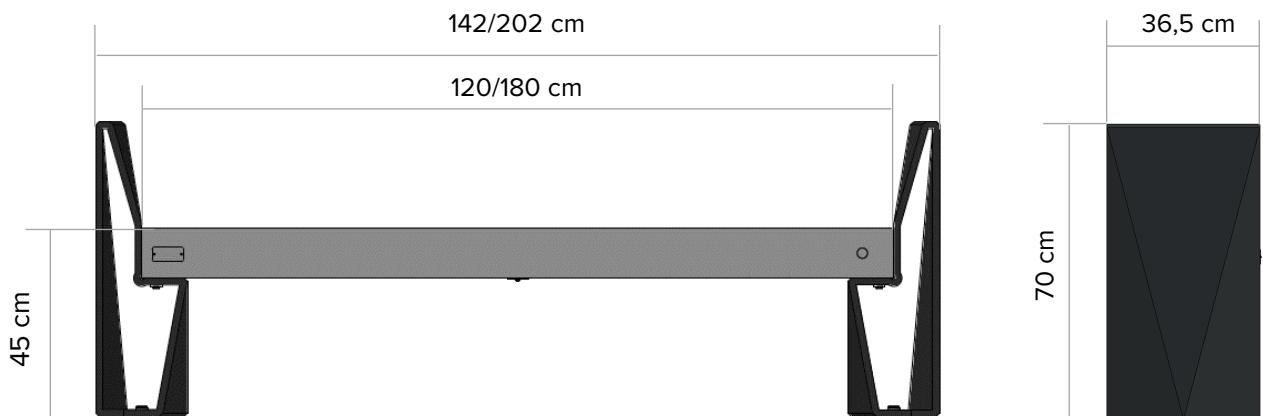
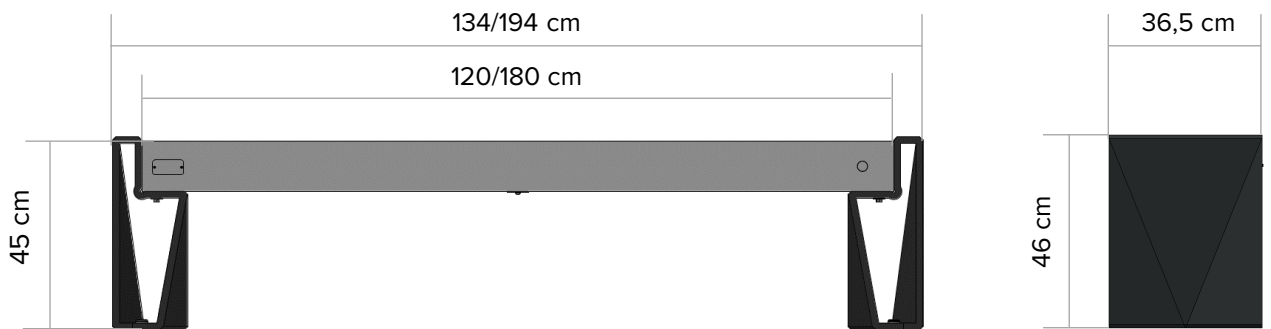

Version 120: 57 kg
Version 120 avec accoudoir: 63 kg
Version 180: 75 kg
Version 180 avec accoudoir: 82 kg

couleurs

Planches

 Mineral Grey

 Sand Beige

Pieds

 Black

renforcement

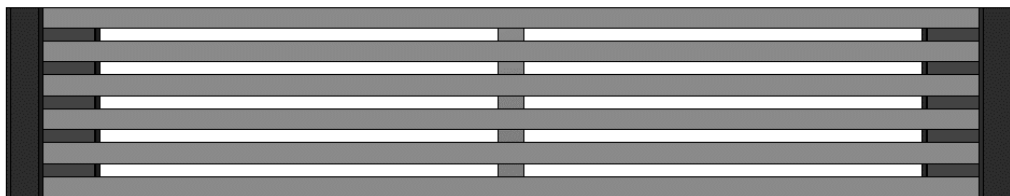

Bande métallique vissée sous les 6 planches

ancrage obligatoire

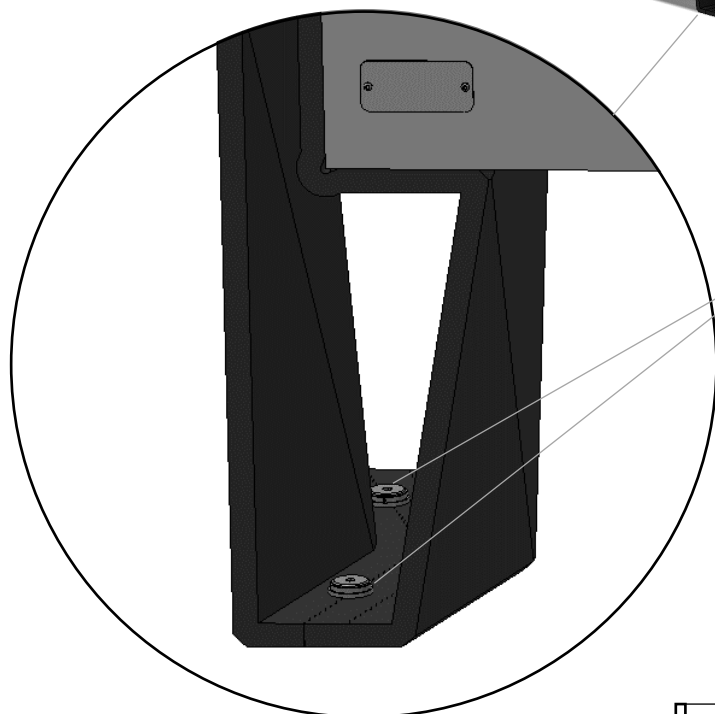
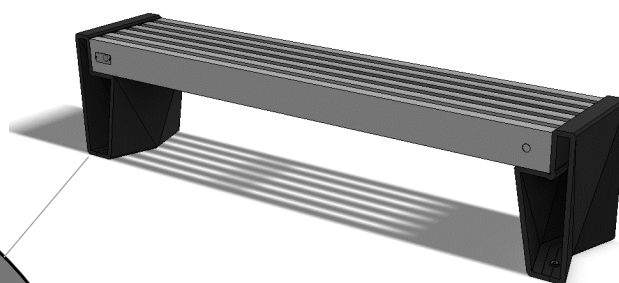

2 pour chaque pied

- Écrou douille inox M10 x 20 mm
- Rondelle ressort inox M16
- Rondelle inox M16
- Tige filetée galvanisée M10 x 250 mm

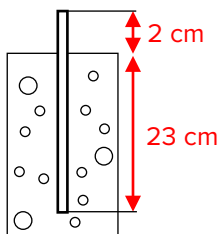

Fixer la tige filetée dans un béton adapté à votre situation



Prisma 120 et 180 (large)

avec ou sans dossier ou accoudoir

Govoplast planches recyclées
en combinaison avec des
pieds imprimés en 3D



dimensions

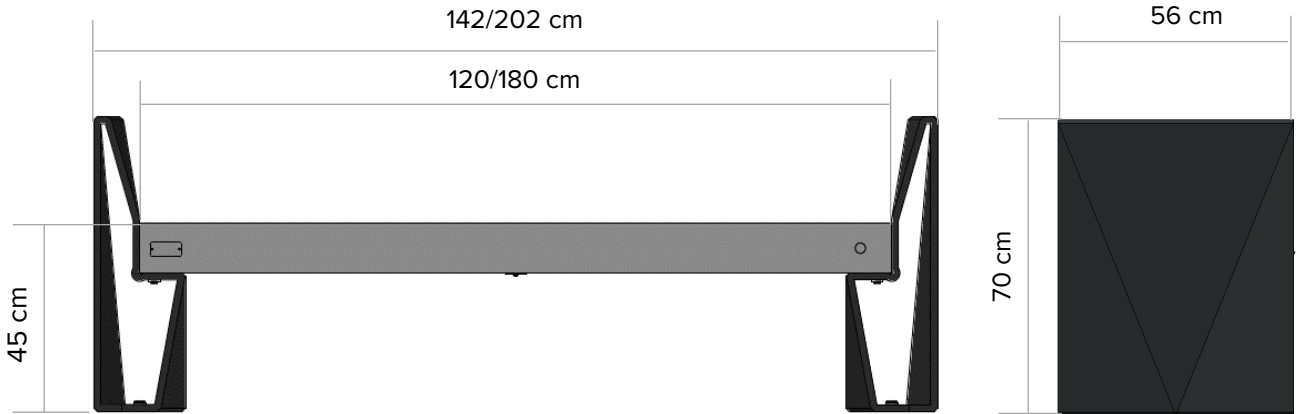
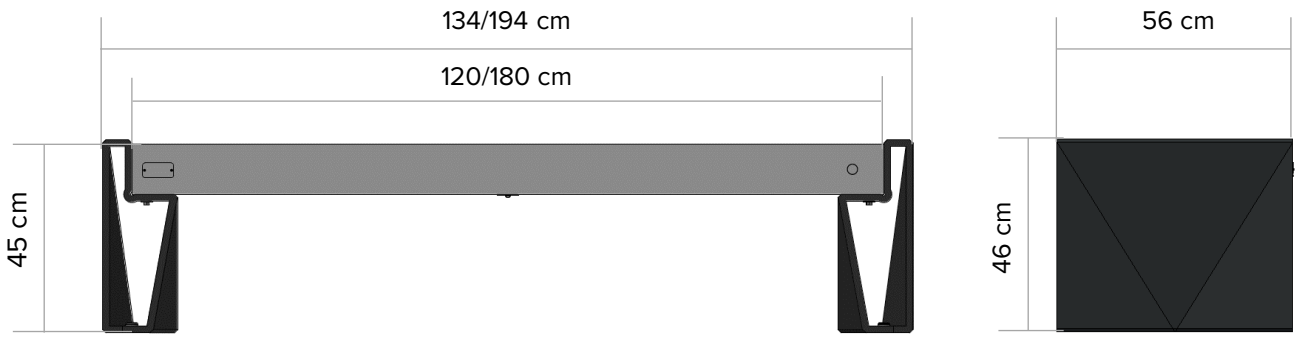

Dossier optionnel
Nombre et position à choisir

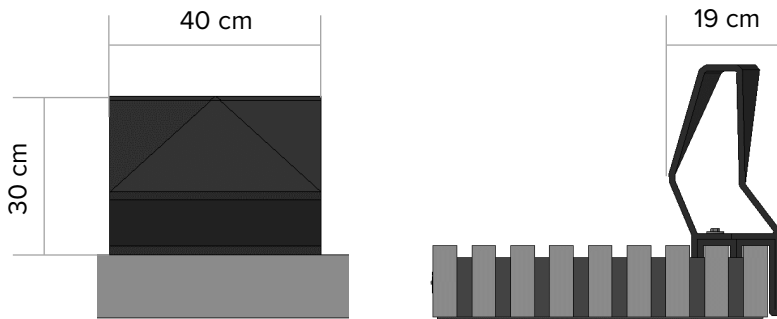

Version 120: 85,5 kg
Version 120 avec accoudoir: 95 kg
Version 180: 114 kg
Version 180 avec accoudoir : 124 kg
Un accoudoir : 7 kg

couleurs

Boards

 Mineral Grey

 Sand Beige

Legs

 Black

renforcement

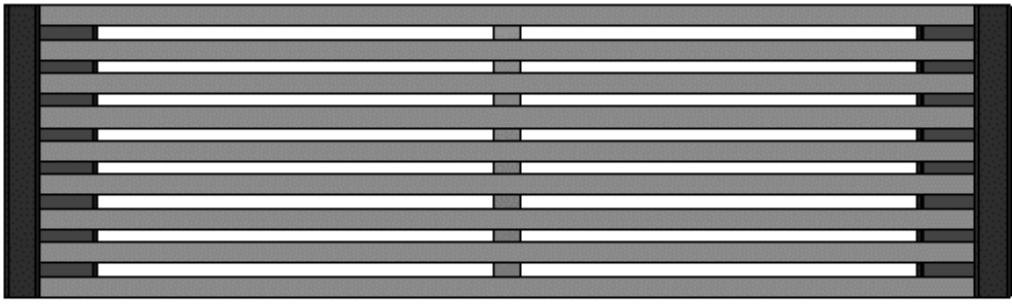

Bande métallique vissée sous les 9 planches

ancrage obligatoire

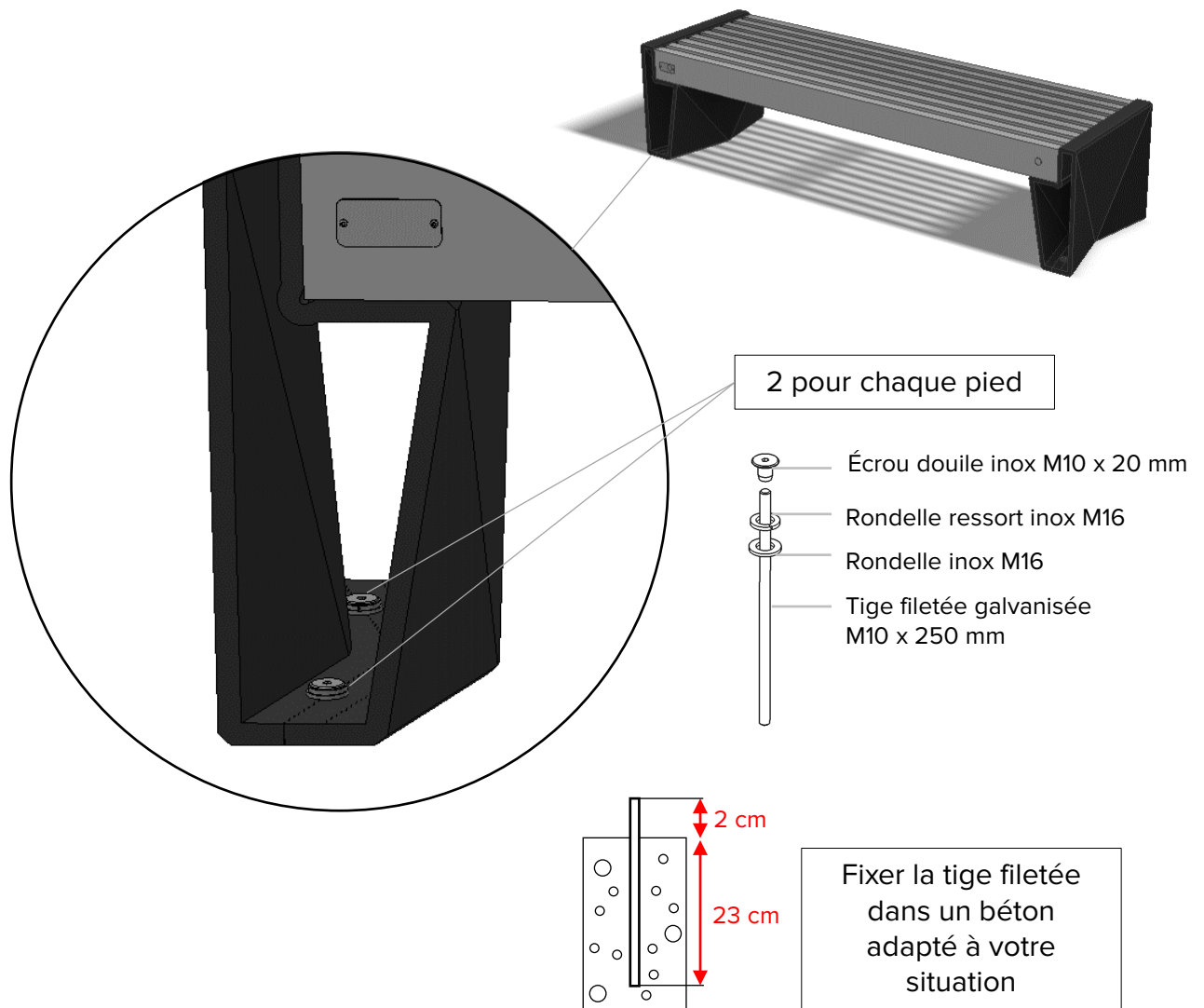



Prisma 360 (étroit)

avec ou sans accoudoir

Govaplast planches recyclées
en combinaison avec des
pieds imprimés en 3D



dimensions

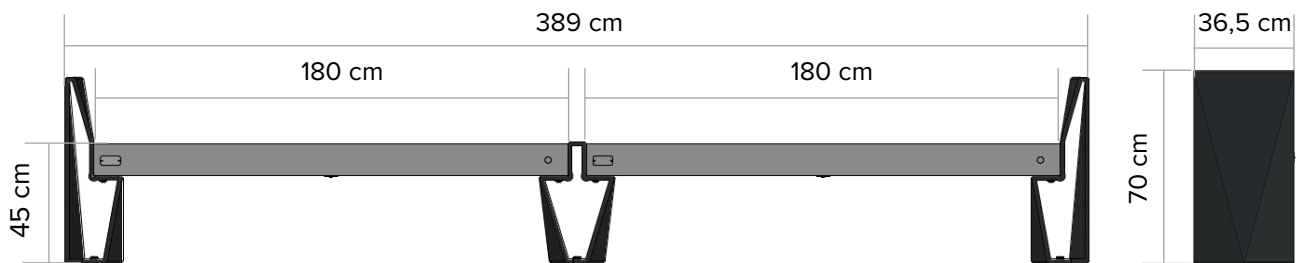
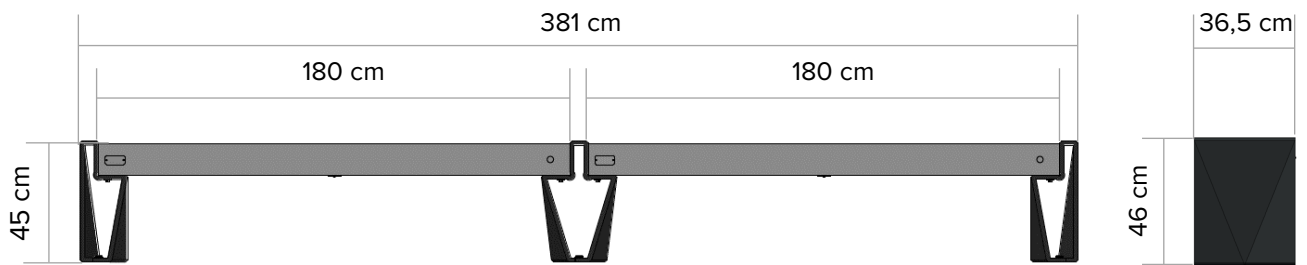

Version 360: 145 kg
Version 360 avec accoudoir: 152 kg

couleurs

Boards

 Mineral Grey

 Sand Beige

Legs

 Black

renforcement

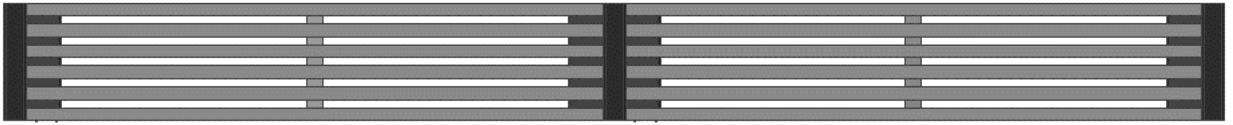

Bande métallique vissée sous les 6 planches

ancrage obligatoire

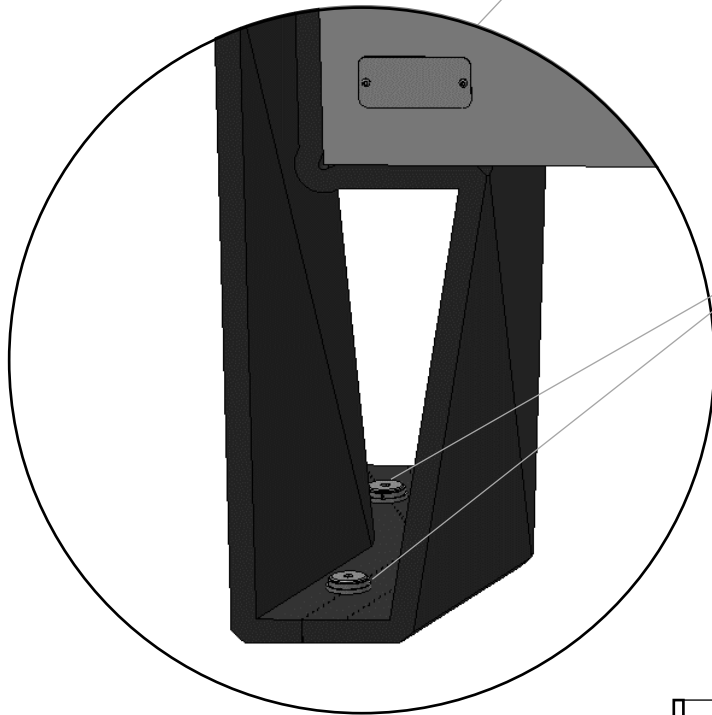
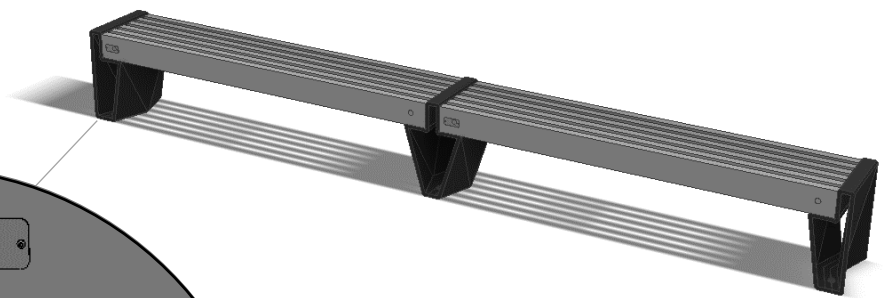

2 pour chaque pied

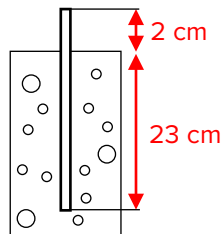
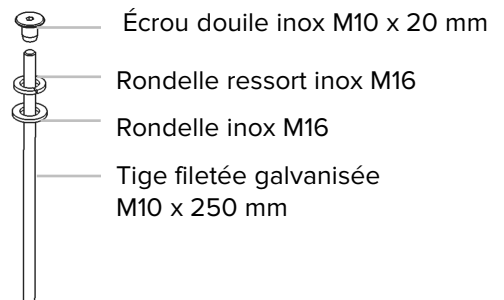

Fixer la tige filetée dans un béton adapté à votre situation

GOVA[®] street
PLAST



Prisma 360 (large)

avec ou sans dossier ou accoudoir

Govaplast planches recyclées
en combinaison avec des
pieds imprimés en 3D



dimensions

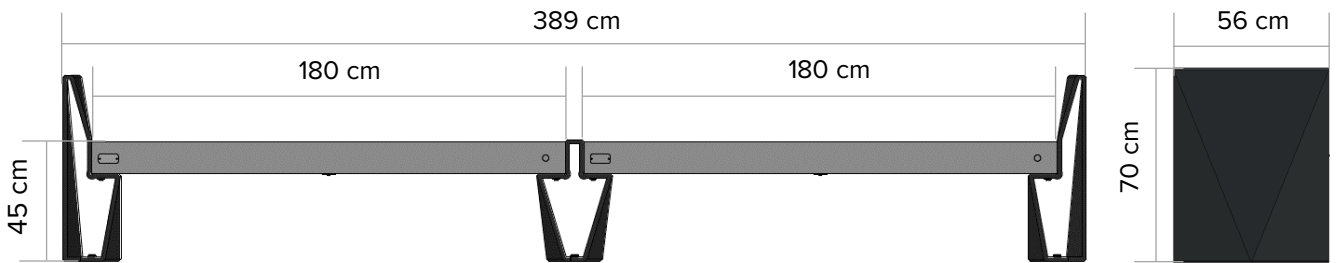
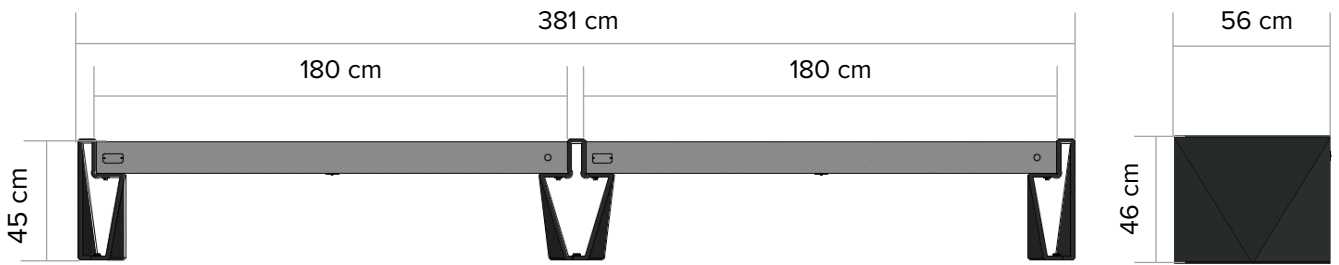

Dossier optionnel
Nombre et position à choisir

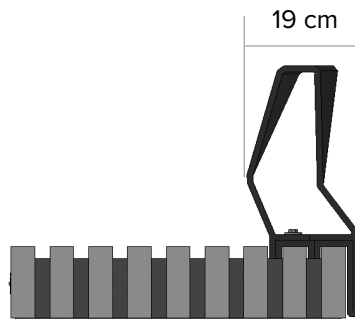
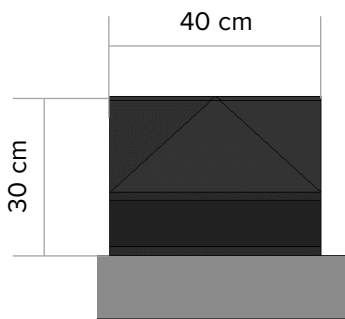

Version 360: 218,5 kg
Version 360 avec accoudoir : 228 kg
Un accoudoir : 7 kg

couleurs

Boards

 Mineral Grey

 Sand Beige

Legs

 Black

renforcement

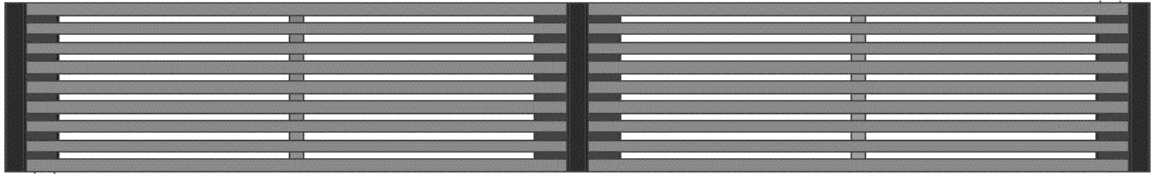

Bande métallique vissée sous les 9 planches

ancrage obligatoire

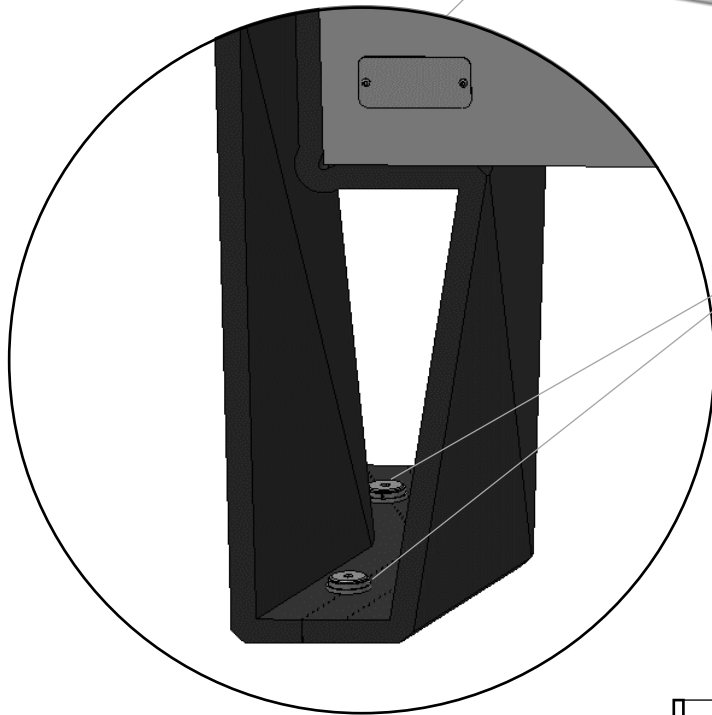
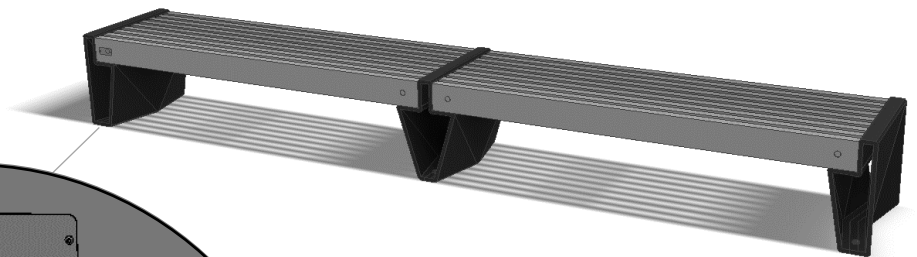

2 pour chaque pied

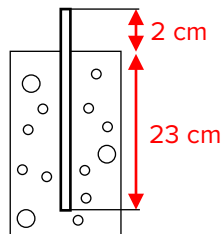
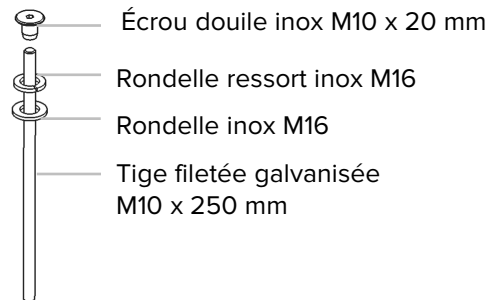

Fixer la tige filetée dans un béton adapté à votre situation